

. 318, , 20, ,  
./ (380 44) 456-8277  
E-mail: berdanovaO@yandex.ru

. 318, , 20, ,  
./ (380 44) 456-8277  
E-mail: ukrmisto@yandex.ru

. 129, , 20, ,  
./ (380 44) 456-0418  
E-mail: vtertychka@yahoo.com  
<http://www.uapa-csar.org.ua>

- : . / , 2004. /  
 – . 1; 3; 5 // [www.uapa-csar.org.ua/ua-2004-2.htm](http://www.uapa-csar.org.ua/ua-2004-2.htm)
- / . . ' . – ∴ , 2004. – . 19-41; 245-264.
- . ,, . ,, : . . . – : , 2004. –  
 .6-21; 46-57
- . . : . , . – . ,  
 2004. – .3-22.

- : . . - ∴ , 1989. - 519 .
- „ . . . . . /
- ( , )
- - . - “ ”, 2003. - 510 . . - ∴
- . . „ “ “ ”, 2002. - 560 .
- / ” . - . - ∴ - “ ”, 2002.- 232 .
- - ; . . . - ∴ - “ ”, 2002.- 232 / . -
- « » . / , 1999. - 440 . . - ∴
- . . ; . . . ; . . . ; . . . ; . . . /
- 2002. - 41 . . . . . - ∴ ,
- : , 1998. - 108 . / . . - ∴
- . . „ / . . . . . , . . . - ∴ ,
- , 1998. - 576 .
- . . ∴ - , 2001. - 302 .
- www.kmu.gov.ua - ( )
- www.intellect.org.ua –

1

“

■

■

”



: STRATOS —

, ; AGOS — .

( . — ∴ . ., 1988. — . 630) — . .

; ,

- (

/ . , . : 4 . - . 4. - ∴ , 1999. - .  
417).

— ...



...

:	:
( 3 )	( 1 )





,

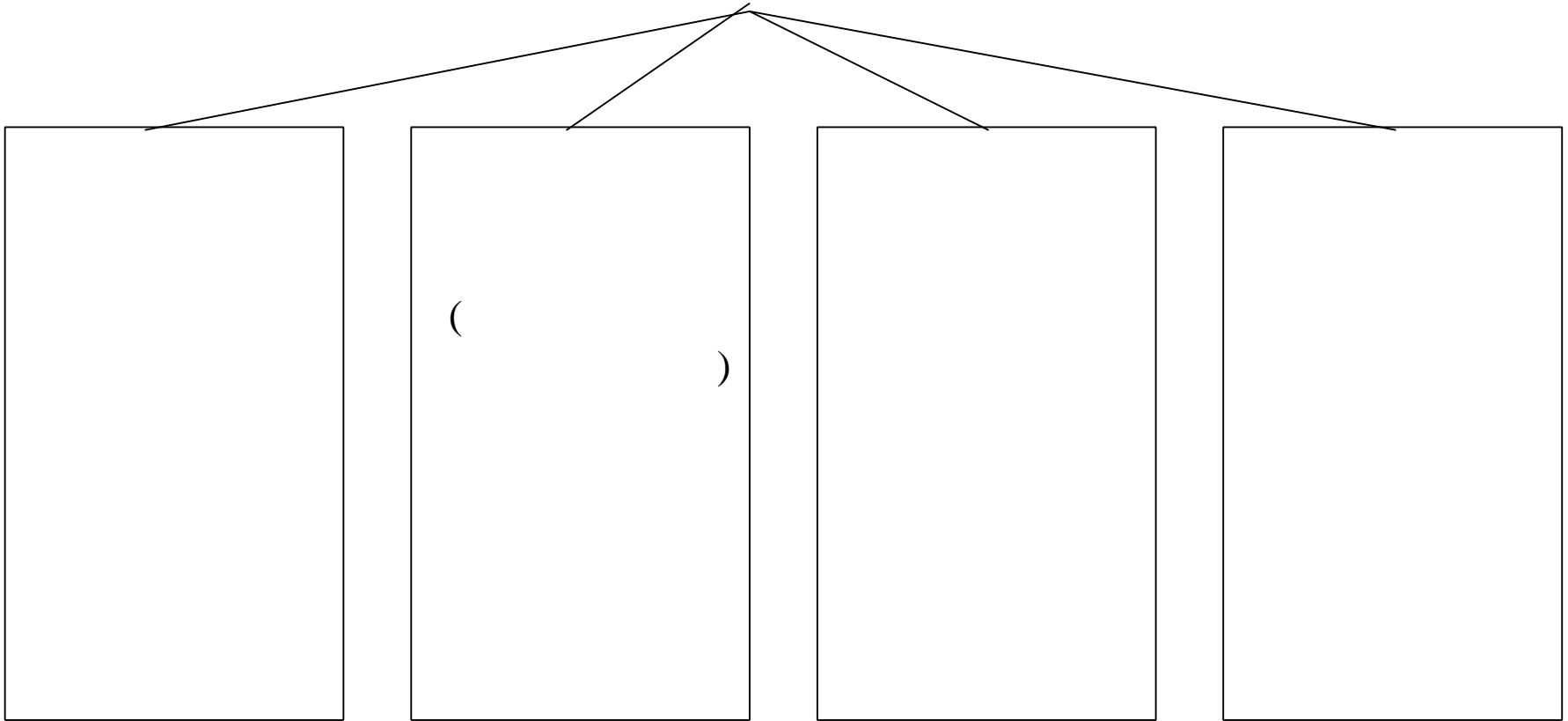

•

•

•

•

•

■

■

,

,

,

,

,

,

,

!

,

,

.

,

- -

■

( ) ,

▪  
,

,

▪



	,	,
	,	,
	— ,	— ,
	,	,
	,	,



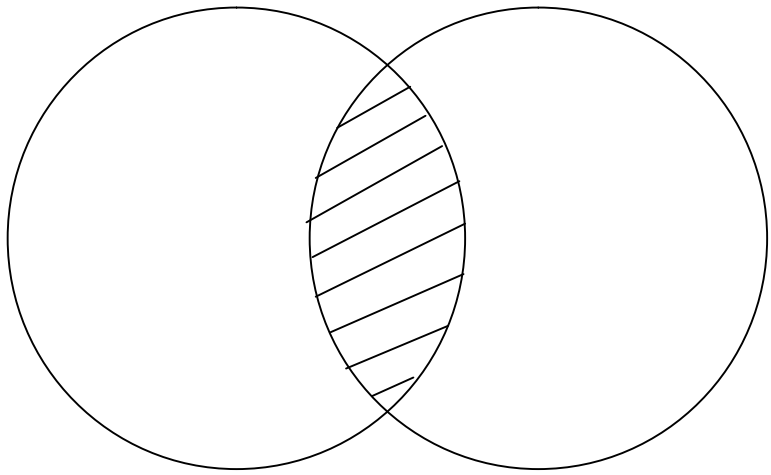

“

,

,

.

,

,

”

.



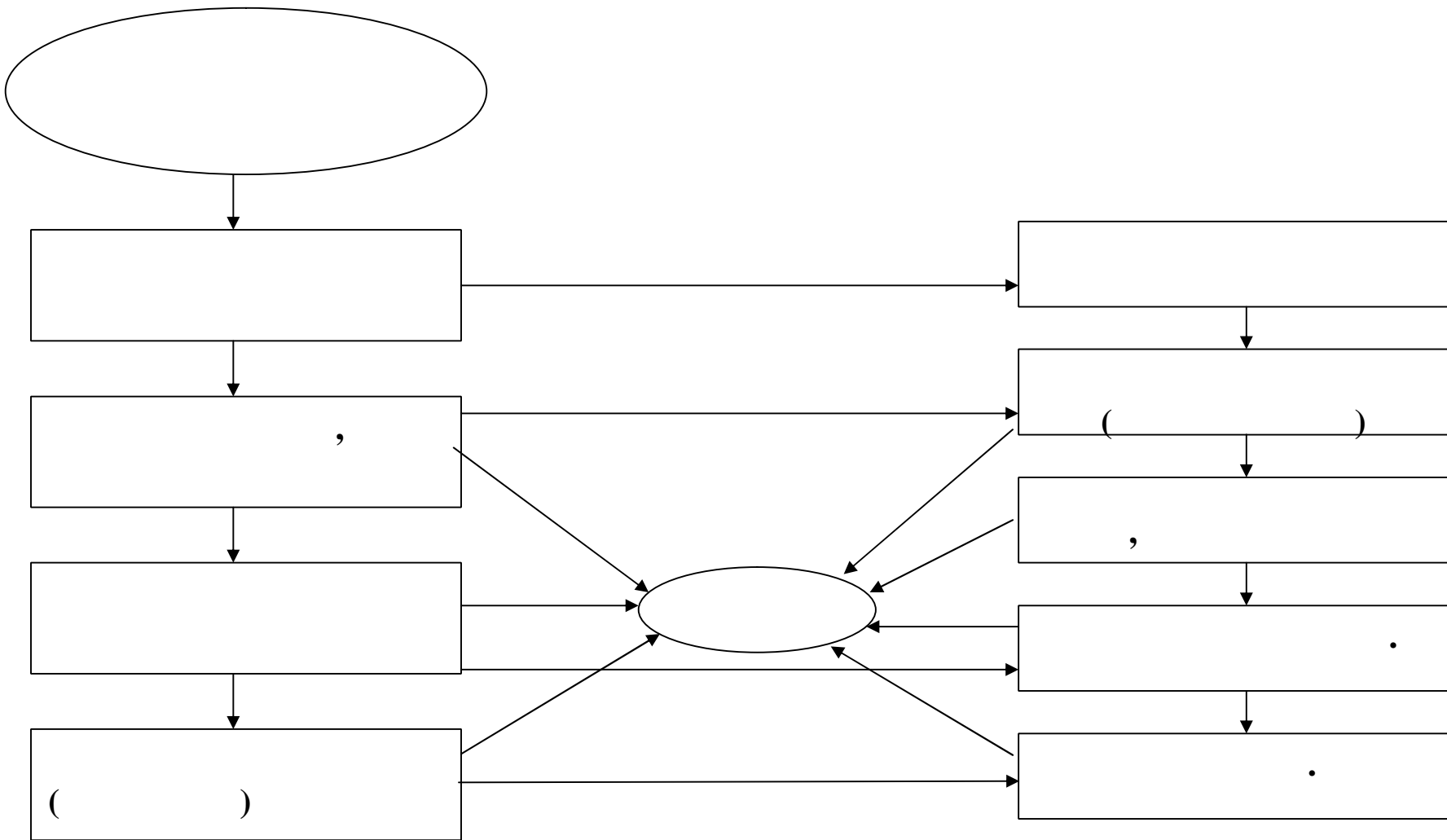

,

,

,

,

▪

,

,

,

▪

▪

▪

—

—

,

,

▪

,

▪

,

,

,

▪



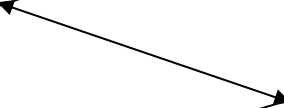
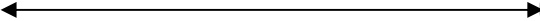
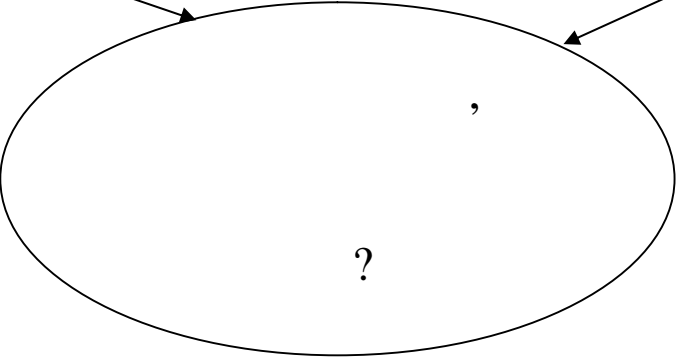
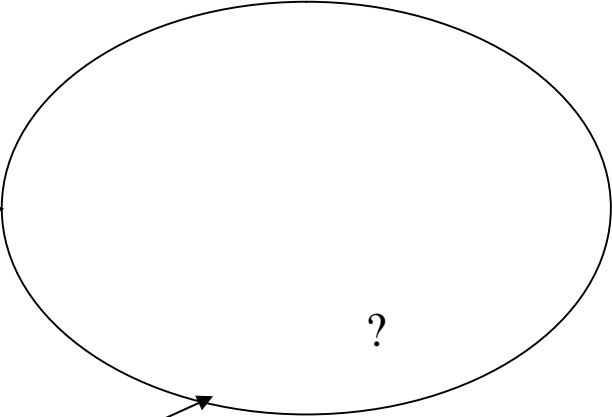
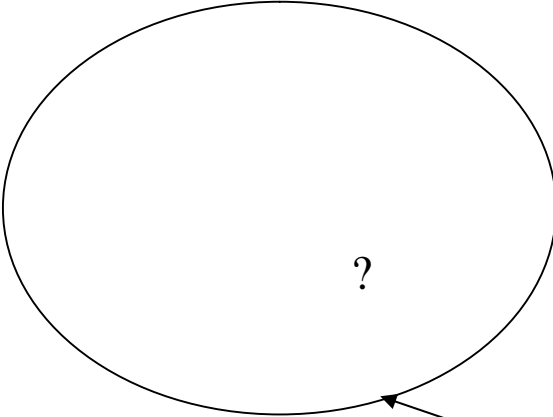



,

,

-

,

,

,

,

-

,

,

,

,

,

,

—

▪



▪

,

▪  
▪

,

▪  
,

▪  
,

●

●

●



·

·

—

—

,

·

,

·

—

”

-

”

4

2006

504- .



,

,

,

:

,

;

(

,

.



.

,

,

(

-

),

,

)

-

-

,

•

•

•

•

⋮

⋮  
,

⋮  
,

⋮

⋮  
,

,

,

(

) (

)

,

-

,

▪

:

;

•

•

•

;

,

,

▪

(

);

•

;

;

•

▪

,

■



,

,

.

—

,

,

,

,

,

⋮

•

•

•

•

-

⋮  
,

—

⋮  
,



,

,

;

,

;

,

;

;

;

;

⋮

●

,

⋮  
;

●

,

⋮  
;

●

●

●

●

⋮

-

⋮  
,

-

⋮  
,

-

⋮

■  
■

,

,

■

,

,

■

•

,

•

,

•

?

⋮

?

?







\_\_\_\_\_ -

\_\_\_\_\_ -

\_\_\_\_\_ -

V \_\_\_\_\_ -

V \_\_\_\_\_ -

V \_\_\_\_\_ -

V \_\_\_\_\_ -

(SWOT- )

, ,

,



■  
■

\_\_\_\_\_

,

,

,

,

\_\_\_\_\_

\_\_\_\_\_

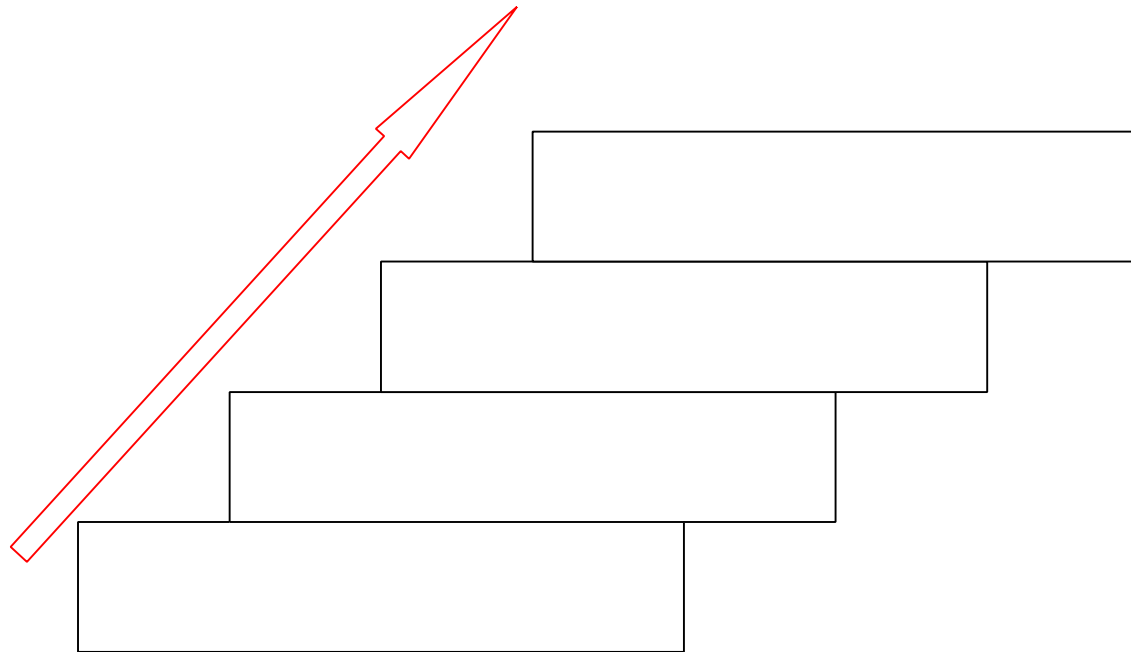

,

■  
■

# SWOT- ( )

(Strengths, Weaknesses, Opportunities, Threats:

, , , .

\_\_\_\_\_

\_\_\_\_\_

\_\_\_\_\_

\_\_\_\_\_

\_\_\_\_\_

\_\_\_\_\_

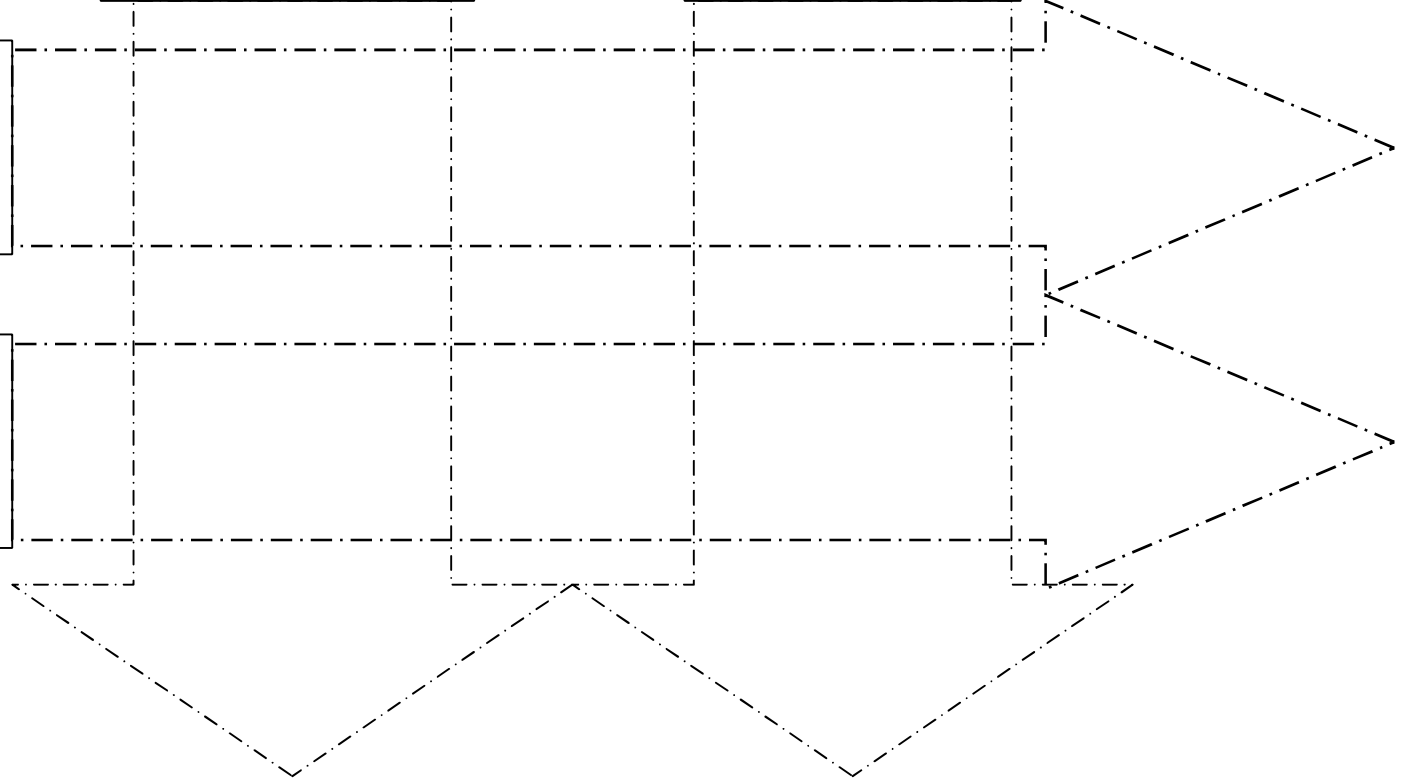

-

( )

		?
?	,	, ,
?	,	, , , , ,
?	,	, ,
?	,	, ,



—

--	--	--

# SWOT

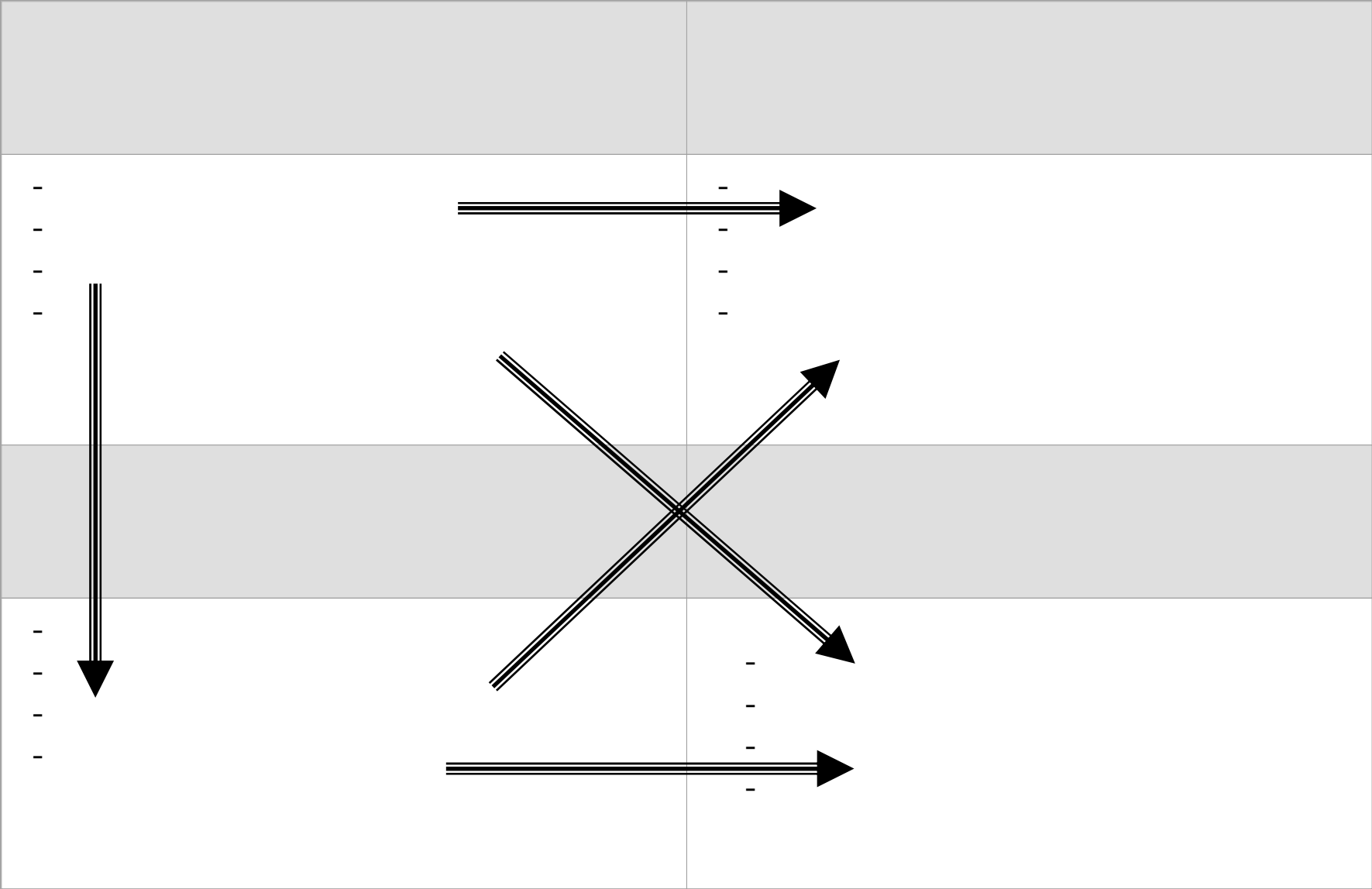





—

,

,

,

,

▪

,

—

,

,

,

,

▪

—

■

,

,

■  
■

,

,

■  
■

,

—

■



—

■

—

,

,

■

,

■

■  
■

,

,

:

( )

( ),

( ).

( = 2-3 = 4-6 )

)

(

,

,

.

“ ( ( 31 2007 . 106) ”

\_\_\_\_\_

,

▪

,

,

,

—

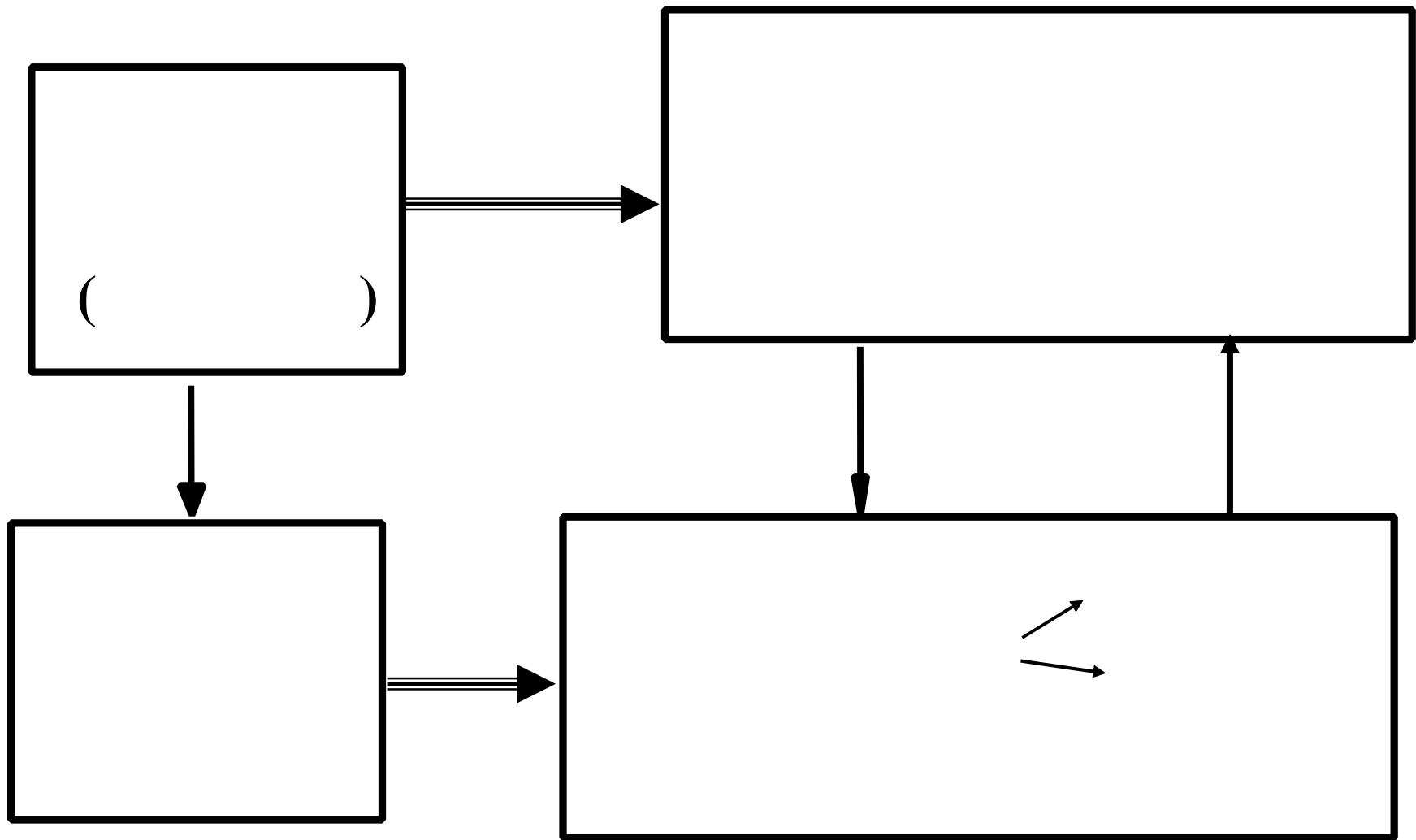

- 
- 
- 
- 
- 
- 
- 
- 
- 

?

—

—

,

—

.

,

?

?

⋮

?

?

?

?

?

—

,



2

“

”

”

-

”

( ’

)

...

—

,

( ),

,

,

,

⋮

,

•

( )

,

?

•

?

—

,

,

,

,

,

(

),

,

,

,

,

:

•

\_\_\_\_\_

\_\_\_\_\_

,

.

,

•

\_\_\_\_\_

\_\_\_\_\_

.

,

•

,

.

•

•

•

•

▪

;

▪

;

,

,

,

,

▪

;

,

▪

▪

▪

,

,



·

·

·

·

·

·

·

”

”

·

·

·

·

·

·



■

. 22

,

,

,

,

-

,

.

:

( )

.

,

,

,

.

●

●

.

—

—

—

—

—

—

,

,

,

,

,

,

,

,

,

:

,

,

.

,

,

,

—

( , ) ,

,

-

,

,

▪

—

( )

,

,

(

,

,

)

⋮

,

⋮  
,

●

●

●

●

●

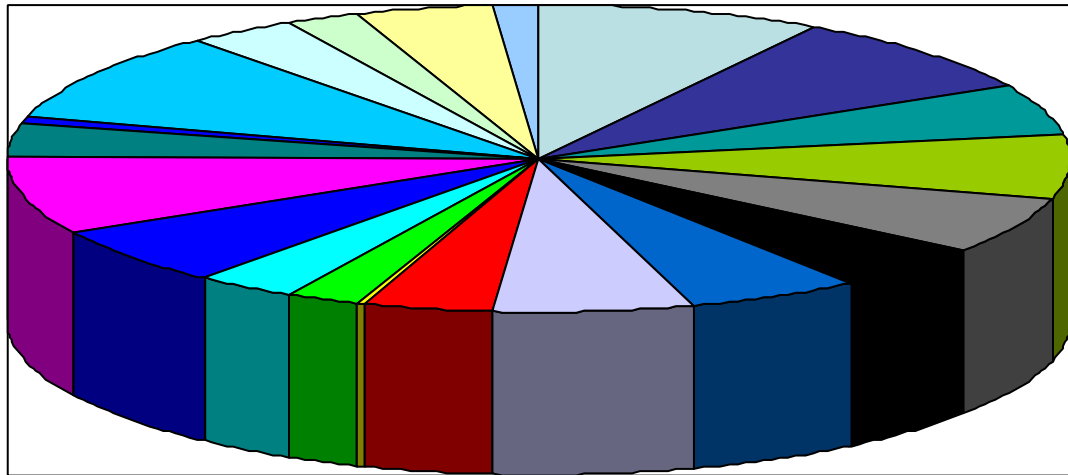

•

▪



”

” [1, .2.2]

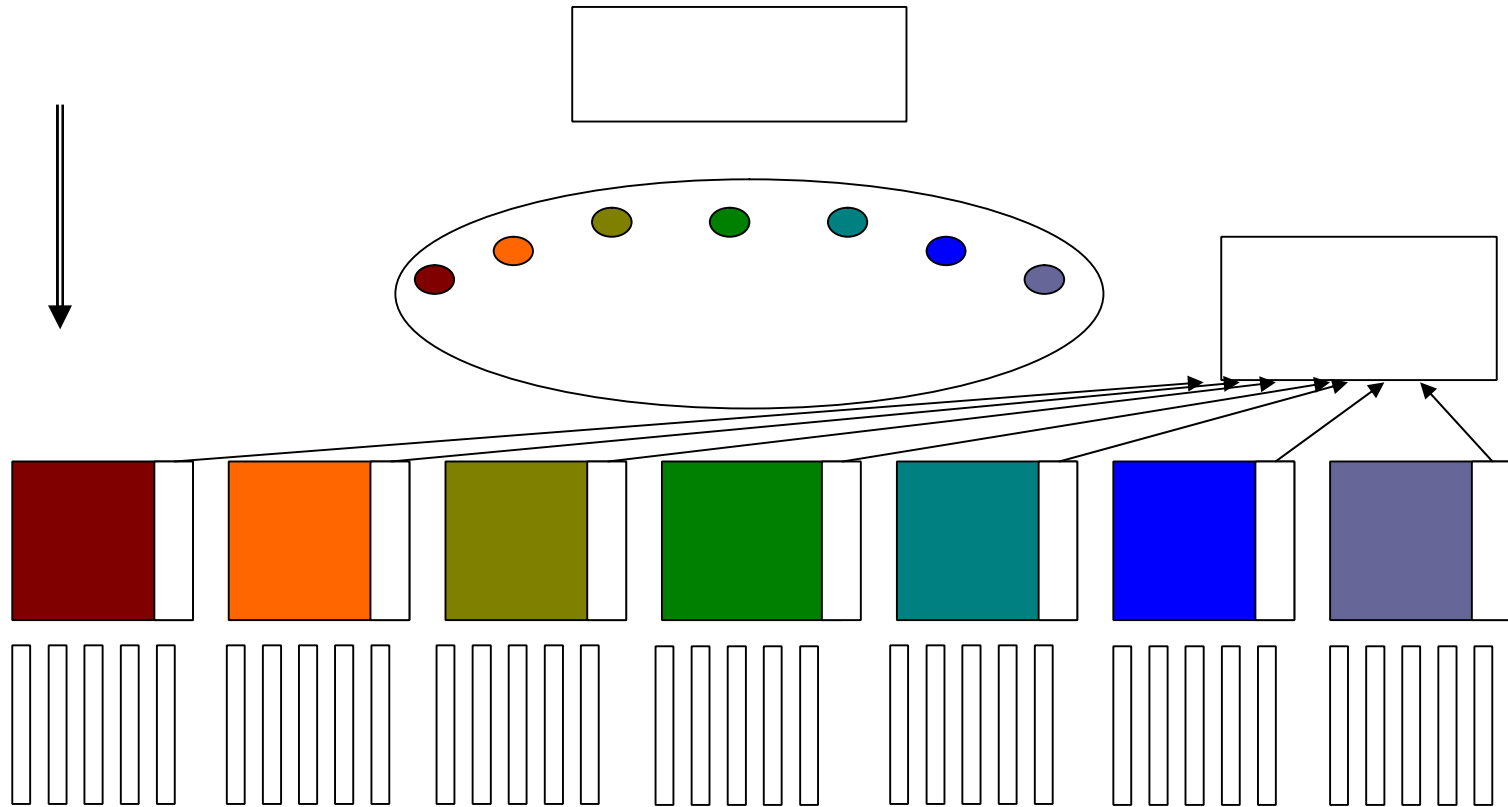

,

,

(

,

(1998-2005 .)

)

— , ) , (

— ( , ' ) ,

— ,

— ,

— ,

— ,

— ( ' )

— ,

— ,

( " [1, .2.2])



	,
	,
	,
	( )



1.

( : , )

•

;

•

( ) ;

•

,

,

;

•

.

2.

SWOT-

(

)

:

/

—

•

,

—

▪

,

,

▪

,

,

,

▪

•

—

,

,

▪

/

—

,

,



# 3.

—

, ( )

, ,

.

,

,

,

.

.

). (

# 4.

,

,

,

▪

,

▪

:

;

•

•

•

•

•

•

•

•

•

•

;

;

/

(

);

;

;

;

,

;

,

▪

●

●

●

●

●

,

⋮

,

?

,

.

•

(

,

■  
■

, ' ,

' );

•

;

,

•

;

•

;

•

;

•

# 5.

—

- (Specific): **SMART,** :
- (Measurable): ;
- (Aggressive but Attainable): ;
- (Results-oriented): ;
- (Time-bound): —

■  
■

■  
■

■  
;

■  
;

■  
;

■  
;

●

●

●

●

●

6.

—

,

:

•

( , ),

,

;

•

;

•

,

.



7.

,

”

”

(

)

- ’

,

,

:

---

(1)

	, ? ? ?
,	, ? ? ?
	? ? ?
	? ? ? ,
	? ? ?

(2)

	‘ ? ? ‘ ? ‘ ?
	‘ ‘ ? ‘ ‘ ? ‘
	‘ ? ‘ ? ‘ ? ‘



